

## Drop-In Drop-in refrigerated quartz surface - 5GN

ITEM # \_\_\_\_\_

MODEL # \_\_\_\_\_

NAME # \_\_\_\_\_

SIS # \_\_\_\_\_

AIA # \_\_\_\_\_

**341086 (D21C5)**

 Drop-in refrigerated quartz  
 surface (5 GN container  
 capacity)

### Short Form Specification

**Item No.** \_\_\_\_\_

Designed to be positioned in flush installation providing improved cleanability and suitable for modern design installations. Designed to serve the food on plates. Food introduced at the correct temperature maintains its core temperature according to Afnor Standards. Automatic defrosting guarantees evaporators clearance and efficient cooling. Digital control with temperature display with precise adjustment (0,1°C). Fully compliant HACCP digital controls include visible alarms. The bottom is equipped with copper tubes to ensure proper cooling, with this system the air touches the cold surface and gets cooled. It comes with stylish white coloured quartz top and stainless steel frame that makes it ideal to serve cold dishes in an elegant way. Equipped with a drain hole to easily discharge top condensation. AISI 304 Stainless steel frame with rounded corners to facilitate cleaning operations. High-density expanded polyurethane foam with cyclopentane guarantees excellent well insulation to reduce energy dispersion. R290 refrigerant gas (GWP=3) to reduce environmental impact and increase cooling efficiency.

### Main Features

- CB and CE certified by a third party notified body.
- Designed to be positioned in flush installation providing improved cleanability and suitable for modern design installations.
- Precise temperature control and setting at 0,1°C .
- As standard the product comes with digitally controlled thermostat which is in line of HACCP norms and provides visual alarm as a warning of the increasing or decreasing temperatures.
- Available drop-in dimensions: 1, 2, 3, 4, 5, 6 GN.
- Food introduced at the correct temperature maintains its core temperature according to Afnor Standards.
- Automatic defrosting guarantees evaporators clearance and efficient well cooling.
- Remote version is available.
- Designed to serve the food on plates .
- Equipped with a drain hole to easily discharge top condensation.
- It comes with stylish white coloured quartz top and stainless steel framed that makes it ideal to serve cold dishes in an elegant way.

### Construction

- Electronic control with temperature display.
- IPx2 water protection.
- The bottom is equipped with copper tubes to ensure proper cooling, with this system the air touches the cold surface and gets cooled.
- AISI 304 Stainless steel frame with rounded corners to facilitate cleaning operations.
- White quartz surface (other quartz colors are available on request).

### Sustainability



- Hydrocarbon refrigerant gas R290 for the lowest environmental impact (GWP=3) - CFC and HCFC free.
- High-density expanded polyurethane foam with cyclopentane guarantees excellent well insulation to reduce energy dispersion.

**APPROVAL:** \_\_\_\_\_

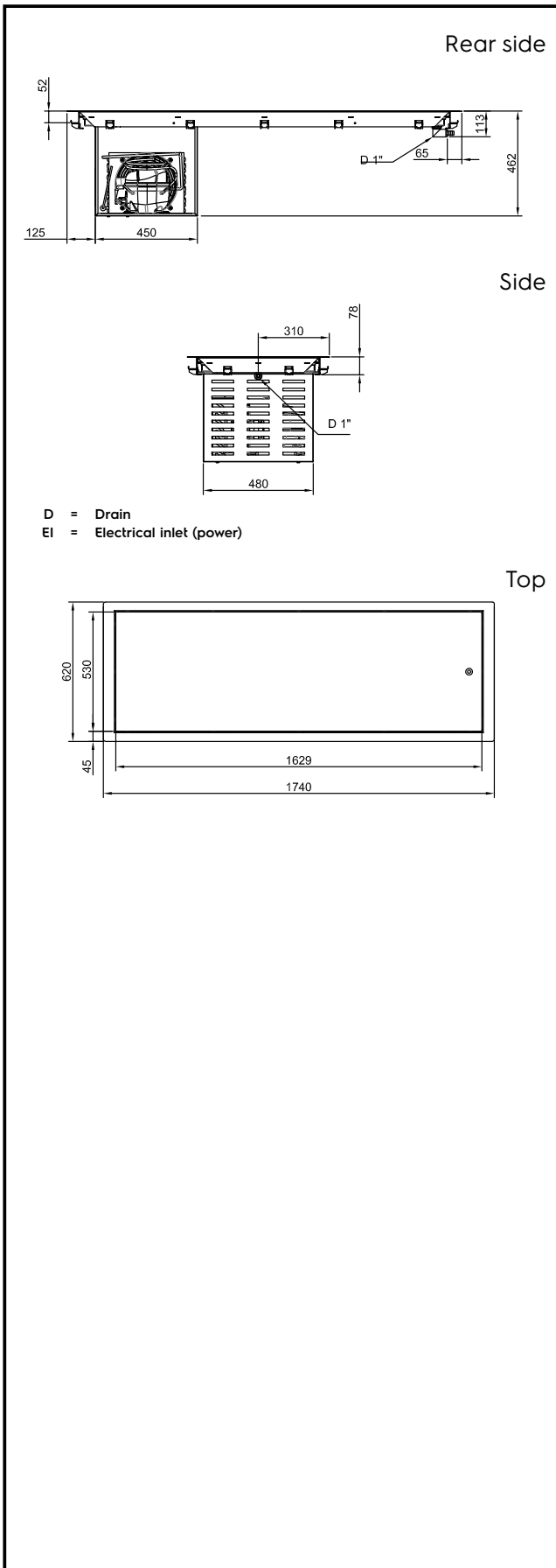

## Electric

Supply voltage:

341086 (D21C5) 220-240 V/1N ph/50 Hz

Electrical power max.:

0.6 kW

## Water:

Water drain outlet size:

1"

Drain line size:

1"

## Key Information:

External dimensions, Width: 1740 mm

External dimensions, Depth: 620 mm

External dimensions, Height: 380 mm

Net weight: 56.5 kg

Shipping weight: 118 kg

Shipping height: 430 mm

Shipping width: 660 mm

Shipping depth: 1790 mm

Shipping volume: 0.51 m<sup>3</sup>

Set temperature: -10 / 0 °C

Top temperature: -10 / 0 °C

## Refrigeration Data

Refrigerant type: R290

## Sustainability

Noise level: 59 dBA

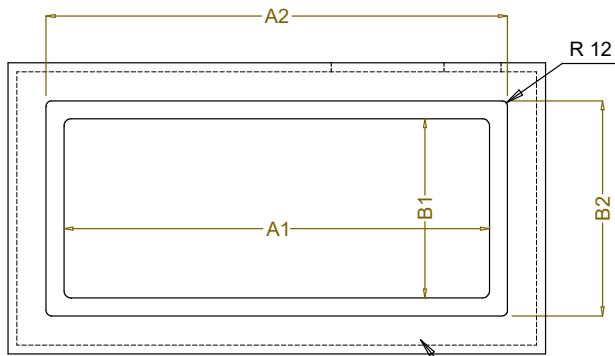
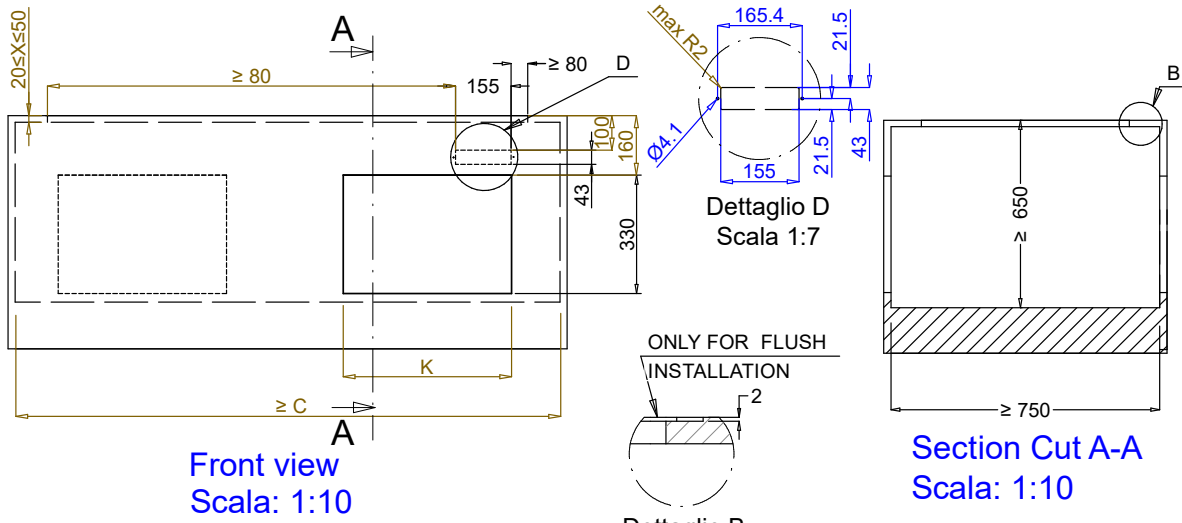

CAPACITY	CUTOUT		LOWERING FOR FLUSH INSTALLATION		C	K
	A1	B1	A2	B2		
1GN	355	560	454	624	535	380
2GN	680		774		855	
3GN	1010		1104		1190	
4GN	1330		1424		1510	
5GN	1660		1744		1835	
6GN	1985		2074		2165	

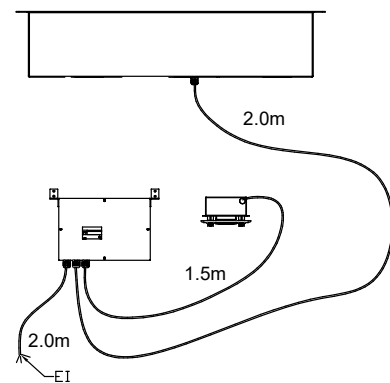
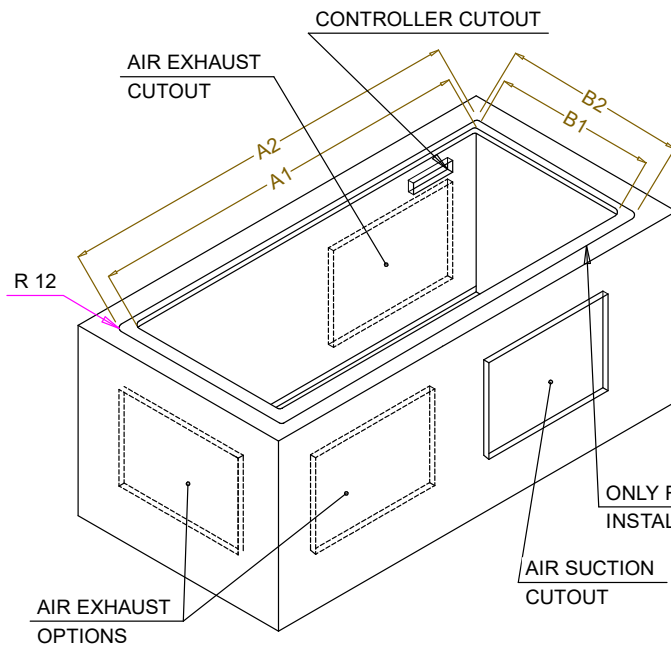

**595T01Q00 - COLD QUARTZ SURFACE**